

UtiliGuard[®] 2

Operator's Manual



CMW[®]

Issue 1.1
Original Instruction

790-1231

Overview

Chapter Contents

Serial Number Location 2

System Components 6

- Receiver 3
- Transmitter 3
- Accessory Ports 4

Intended Use 5

Equipment Modification 5

Regulatory Notices 6

- United States 6
- Canada 6
- EU Declaration of Conformity 7
- Interference 7

About This Manual 7

- Bulleted Lists 7
- Numbered Lists 7

California Proposition 65



Cancer, birth defects, and other reproductive harm. www.P65warnings.ca.gov.

Serial Number Location

Record serial numbers and date of purchase in spaces provided. Serial numbers are located as shown.

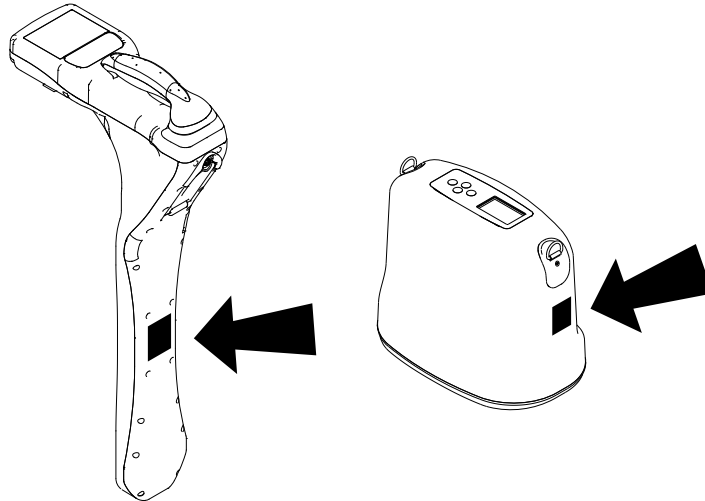

e18om029h.eps

Item	
Date of manufacture	
Date of purchase	
Receiver serial number	
Transmitter serial number	

System Components

Receiver

Model	Standard Features
UtiliGuard 2 Classic	Over 70 preset frequencies, configuration software
UtiliGuard 2	Over 70 preset frequencies, configuration software integrated GPS, metrics and logging
UtiliGuard 2 Advanced	Over 70 preset frequencies, configuration software, integrated GPS, metrics and logging, receiver/transmitter communication, offset depth, Ambient Interference Measurement (AIM®)

Transmitter

Model	Standard Features
UtiliGuard 2 T5	Over 70 preset frequencies, 5W output, configuration software
UtiliGuard 2 T5 Advanced	Over 70 preset frequencies, 5W output, configuration software, receiver/transmitter communication
UtiliGuard 2 T12	Over 70 preset frequencies, 12W output, configuration software
UtiliGuard 2 T12 Advanced	Over 70 preset frequencies, 12W output, configuration software, receiver/transmitter communication

Accessory Ports

NOTICE: Always replace sealed cover after using mini-USB port.

Receiver

Accessory port (1) is intended for use with only Subsite Electronics-approved accessories.

Mini-USB port (2) is intended for use when connecting to a PC to update software and/or change user configuration.

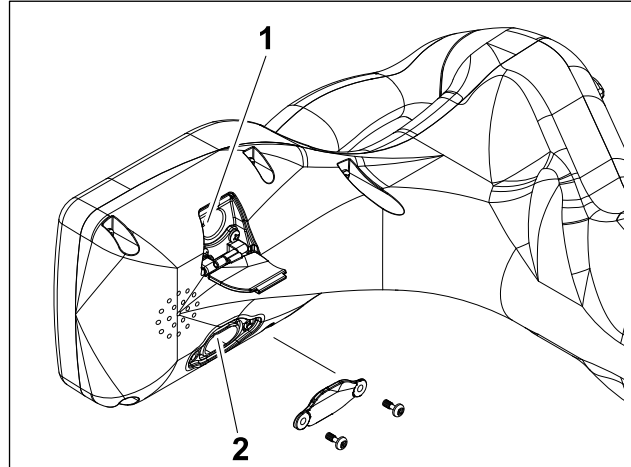

e18om050h.eps

Transmitter

Active location device port (1) is intended for use with only Subsite Electronics-approved accessories.

Mini-USB port (2) is intended for use when connecting to a PC to update software and/or change user configuration.

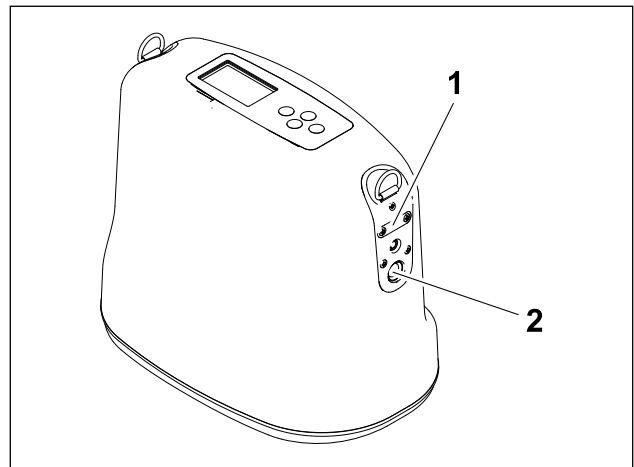

e24om007w20.eps

Intended Use

NOTICE: This equipment is intended for use only with Subsite Electronics® accessories. See “Accessories” on page 45.

The UtiliGuard 2 receiver is designed to locate buried utilities. Over 70 preset frequencies, custom frequencies, and five modes of operation are available for specific locating needs.

The T5 and T12 transmitters place signals on target utilities through either direct connection, induction clamping, or broadcast induction to be detected by UtiliGuard 2 receivers. These transmitters can be configured to send over 70 frequencies as well as custom frequencies.

This system is intended for operation only according to the instructions in this manual. Operate equipment in temperatures from -4° to 122°F (-20° to 50°C). Contact your Subsite Electronics dealer for provisions required for operating in extreme temperatures. Use in any other way is considered contrary to the intended use.

Equipment Modification

This equipment was designed and built in accordance with applicable standards and regulations. Modification of equipment could mean that it will no longer meet regulations and may not function properly or in accordance with the operating instructions. Modification of equipment should only be made at authorized repair centers.

Regulatory Notices

IMPORTANT: Other compliance statements and marks may be viewed on equipment display screen(s).

United States

This device complies with Part 15 of the FCC Rules. Operation is subject to the following conditions: (1) this device may not cause harmful interference, and (2) this device must accept any interference received, including interference that may cause undesired operation. Changes or modifications not expressly approved by **The Charles Machine Works, Inc.** could void the user's authority to operate the equipment.

This machine has been tested and found to comply with the limits for a Class A digital device, pursuant to Part 15 of the FCC rules. These limits are designed to provide reasonable protection against harmful interference when the equipment is operated in a commercial environment. This equipment generates, uses, and can radiate radio frequency energy, and, if not installed and used in accordance with the instructions, can cause harmful interference to radio communications. Operation of this equipment in a residential area could cause harmful interference which the user will be required to correct at his own expense. Changes or modifications not expressly approved by The Charles Machine Works, Inc. could void the user's authority to operate the equipment.

This equipment has been tested and found to comply with the limits for a Class B digital device, pursuant to Part 15 of the FCC rules. These limits are designed to provide reasonable protection against harmful interference in a residential installation. This equipment generates, uses and can radiate radio frequency energy and, if not installed and used in accordance with the instructions, may cause harmful interference to radio communications. However, there is no guarantee that interference will not occur in a particular installation. If this equipment does cause harmful interference to radio or television reception, which can be determined by turning the equipment off and on, the user is encouraged to try to correct the interference by one or more of the following measures:

- Reorient or relocate the receiving antenna.
- Increase the separation between the equipment and receiver.
- Connect equipment into an outlet on a circuit different from that to which the receiver is connected.
- Consult the dealer or an experienced radio/TV technician for help.

Contains FCC ID: QQQWT41, T7VEBMU (Bluetooth accessory V1 and V2)

Canada

CAN ICES-003(B)/NMB-3(B)

This device complies with Industry Canada *license-exempt* RSS standard(s). Operation is subject to the following two conditions: (1) this device may not cause interference, and (2) this device must accept any interference, including interference that may cause undesired operation of the device.

Contains IC: 5123-ABGTWT41, 216QEEMU (Bluetooth accessory V1 and V2)

Le présent appareil est conforme aux CNR d'Industrie Canada applicables aux appareils radio exempts de licence. L'exploitation est autorisée aux deux conditions suivantes: (1) l'appareil ne doit pas produire de brouillage, et (2) l'appareil doit accepter tout brouillage radioélectrique subi, même si le brouillage est susceptible d'en compromettre le fonctionnement.

Contient IC: 5123-ABGTWT41, 216QEEMU (Bluetooth accessory V1 and V2)

EU Declaration of Conformity

Hereby, Charles Machine Works declares that the radio equipment type *UtiliGuard buried utility locating equipment* is in compliance with Directive 2014/53/EU. The full extent of the EU declaration of conformity is available by visiting <https://subsite.com/about-us/contact-us> or by emailing a request to service@subsite.com.

Interference

All tracking and locating equipment is subject to electromagnetic interference. The presence of interference can cause inaccuracies in both location and depth calculations.

Prior to locating utilities, check the jobsite for the presence of any active interference and be mindful of passive interference sources. Sources of both active and passive interference may be buried or otherwise not visible.

Active Interference

Active interference can be caused by utilities, traffic loops, alternators, cell phones, radio towers, cathodic protection, etc.

Passive Interference

IMPORTANT: Setting beacon to a lower frequency typically lessens the effect of passive interference.

Passive interference is the distortion of the magnetic field by large, nearby metal objects. Passive interference can be caused by rebar, metal fences, buried metal pipe, etc.

About This Manual

This manual contains information for the proper use of this machine. Cross references such as “See page 50” will direct you to detailed procedures.

Bulleted Lists

Bulleted lists provide helpful or important information or contain procedures that do not have to be performed in a specific order.

Numbered Lists

Numbered lists contain illustration callouts or list steps that must be performed in order.

Foreword

This manual is an important part of your equipment. It provides safety information and operation instructions to help maintain your Subsite Electronics equipment.

Read this manual before using your equipment. Keep it with the equipment at all times for future reference. If you sell your equipment, be sure to give this manual to the new owner.

If you need a replacement copy, contact your Ditch Witch dealer. If you need assistance in locating a dealer, visit our website at www.ditchwitch.com or write to the following address:

Subsite Electronics
ATTN: Product Support
1950 W. Fir
Perry, OK 73077-0066
USA

The descriptions and specifications in this manual are subject to change without notice. The Charles Machine Works, Inc. reserves the right to improve equipment. Some product improvements may have taken place after this manual was published. For the latest information on Ditch Witch equipment, see your Ditch Witch dealer.

Thank you for buying and using Subsite Electronics equipment.

**UtiliGuard 2
Operator's Manual**

Issue number 1.1/OM-1/22

Part number 790-1231

Copyright 2020, 2022

by The Charles Machine Works, Inc.



Subsite, and Ditch Witch, and DrillLok are registered trademarks of The Charles Machine Works, Inc.

This product and its use may be covered by one or more patents at <http://patents.charlesmachine.works>.

Contents

Overview **1**

Equipment serial number, information about the type of work this equipment is designed to perform, basic equipment components, and how to use this manual

Foreword **9**

Part number, revision level, and publication date of this manual and factory contact information

Safety **13**

Equipment safety alerts and emergency procedures

Controls **17**

Equipment controls and indicators and how to use them

Locate **29**

Procedures for locating active, passive, and beacon signals

Accessories **45**

Information about accessories and how to use them

Maintenance **57**

Maintenance intervals and instructions for this equipment

Specifications **61**

Equipment specifications including weights and measurements

Support **65**

The warranty policy for this equipment and procedures for obtaining warranty consideration and training

Safety

Chapter Contents

Safety Alert Classifications 14

Guidelines 15

Safety Alerts 16

Safety Alert Classifications

These classifications and the icons defined on the following pages work together to alert you to situations which could be harmful to you, jobsite bystanders, or your equipment. When you see these words and icons in the book or on the machine, carefully read and follow all instructions. YOUR SAFETY IS AT STAKE.



When you see this safety alert sign, carefully read and follow all instructions. **YOUR SAFETY IS AT STAKE.** Read this entire section before using your equipment.

Watch for the three safety alert levels: **DANGER**, **WARNING**, and **CAUTION**. Learn what each level means.



DANGER indicates a hazardous situation that, if not avoided, will result in death or serious injury. This signal word is to be limited to the most extreme situations.



WARNING indicates a hazardous situation that, if not avoided, could result in death or serious injury.



CAUTION indicates a hazardous situation that, if not avoided, could result in minor or moderate injury.

Watch for two other words: **NOTICE** and **IMPORTANT**.

NOTICE indicates information considered important, but not hazard-related (e.g., messages relating to property damage).

IMPORTANT can help you do a better job or make your job easier in some way.

Guidelines

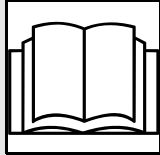

⚠ WARNING

Misuse of equipment can cause death or serious injury. Read and understand operator's manual and all other safety instructions before use.

Follow these guidelines before operating any jobsite equipment:

- Complete proper training.
- Read and understand operator's manual before using equipment.
- Wear personal protective equipment.
- Mark proposed path with white paint and have underground utilities located before working. In the US or Canada, call 811 (US) or 888-258-0808 (US and Canada). Also contact any local utilities that do not participate in the One-Call service. In countries that do not have a One-Call service, contact all local utility companies to have underground utilities located.
- Classify jobsite based on its hazards and use correct tools and machinery, safety equipment, and work methods for jobsite.
- Mark jobsite clearly and keep spectators away.
- Review jobsite hazards, safety and emergency procedures, and individual responsibilities with all personnel before work begins.
- Fully inspect equipment before operating. Repair or replace any worn or damaged parts. Replace missing or damaged safety shields and safety alert signs. Contact your Ditch Witch dealer for assistance.
- Replace missing or damaged safety signs.
- Use equipment carefully per the instructions in this manual. Stop operation and investigate anything that does not look or feel right.
- Contact your equipment dealer if you have any questions about operation, maintenance, or equipment use.

Safety Alerts



⚠ WARNING Lithium cell batteries. Fire or explosion can cause death or serious injury. Follow proper care, handling, and charging precautions. See operator's manual.

To help avoid injury:

- Turn off equipment and remove accessories before opening battery compartment.
- Only charge with approved battery charger.
- Do not crush, heat or incinerate, short circuit, dismantle, or immerse in fluid.
- Use proper disposal.
- Follow proper shipping procedures for Class 9 batteries.



⚠ WARNING Misuse of equipment can cause death or serious injury. Read and understand operator's manual and all other safety instructions before use.

To help avoid injury: Only operate away from explosive devices or blasting operations.



⚠ WARNING Moving traffic - hazardous situation. Death or serious injury could result. Avoid moving vehicles, wear high-visibility clothing, post appropriate warning signs.

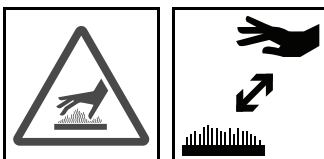

⚠ CAUTION Hot batteries. Contact can cause injury. Only touch when cool or wear gloves.



⚠ WARNING Potential radio frequency (RF) hazard. Operating this device within 8" (200mm) of your body may cause RF exposure levels to exceed FDD RF exposure limits and should be avoided.

Controls

Chapter Contents

IMPORTANT: For control information for accessories, see page 45.

Receiver 18

- Keypad 18
- Display 19
- Menu 23

Transmitter 24

- Keypad 24
- Display 25
- Menu 27





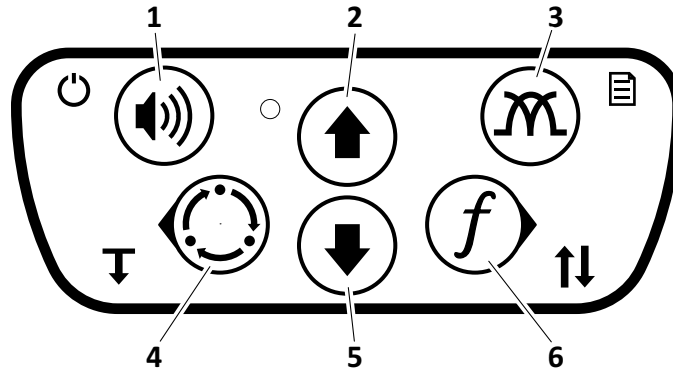





Receiver

Keypad



e24om001w20.eps

IMPORTANT: Keypad buttons perform several functions, depending on operating mode.

Item	Description	IMPORTANT
1. Volume/Power key	 To adjust volume, press.  To turn on or off, press and hold.	When using menu, press to return to locate screen.
2. Gain up key	 To adjust gain up, press.	When using menu, press to move up through menu options.
3. Antenna configuration/Menu key	 To change antenna configuration, press.  To access menu, press and hold.	See "Select Antenna Configuration" on page 36. See "Menu" on page 23.
4. Mode/Depth key	 To move through selected modes, press.  To force depth reading, press and hold.	When using menu, press to return to previous screen. See "Select Mode" on page 36.
5. Gain down key	 To adjust gain down, press.	When using menu, press to move down through menu options.
6. Frequency/Direction enable key	 To move through enabled frequencies, press.  To home direction, press and hold.	When using menu, press to move to next screen or select option. See "Enable Frequency" on page 37. See "Direction Enable" on page 39.

Display

Locating Display

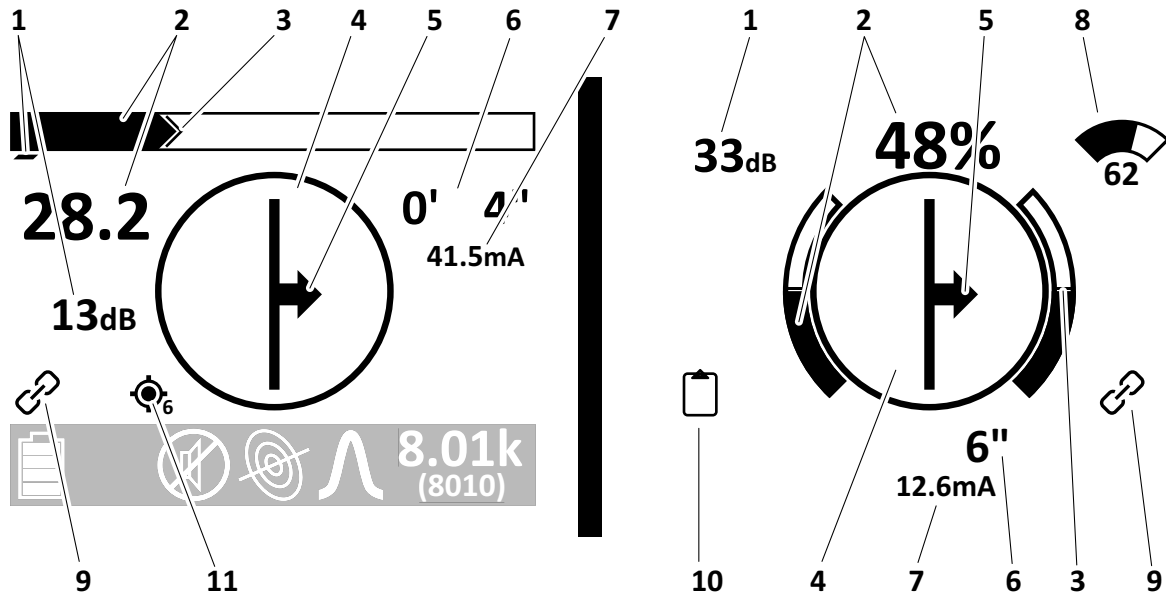











e24om002w20.eps

IMPORTANT: UtiliGuard Classic shown on the right and UtiliGuard 2 and UtiliGuard 2 Advanced shown on the left. User interface can be changed in options menu.

- | | |
|--------------------------|-----------------------------|
| 1. Gain | 7. Current meter |
| 2. Signal strength | 8. Range estimator |
| 3. Peak signal indicator | 9. Communication indicator* |
| 4. Compass | 10. Logging indicator* |
| 5. Direction arrow | 11. GPS status indicator* |
| 6. Depth | |
- *UtiliGuard 2 Advanced only

Item	Description	IMPORTANT
1. Gain	Displays gain.	See "Adjust Receiver Gain" on page 37.
2. Signal strength	Displays signal strength.	
3. Peak signal indicator	Indicates peak signal.	
4. Compass	Compass needle displays orientation of utility.	

Receiver

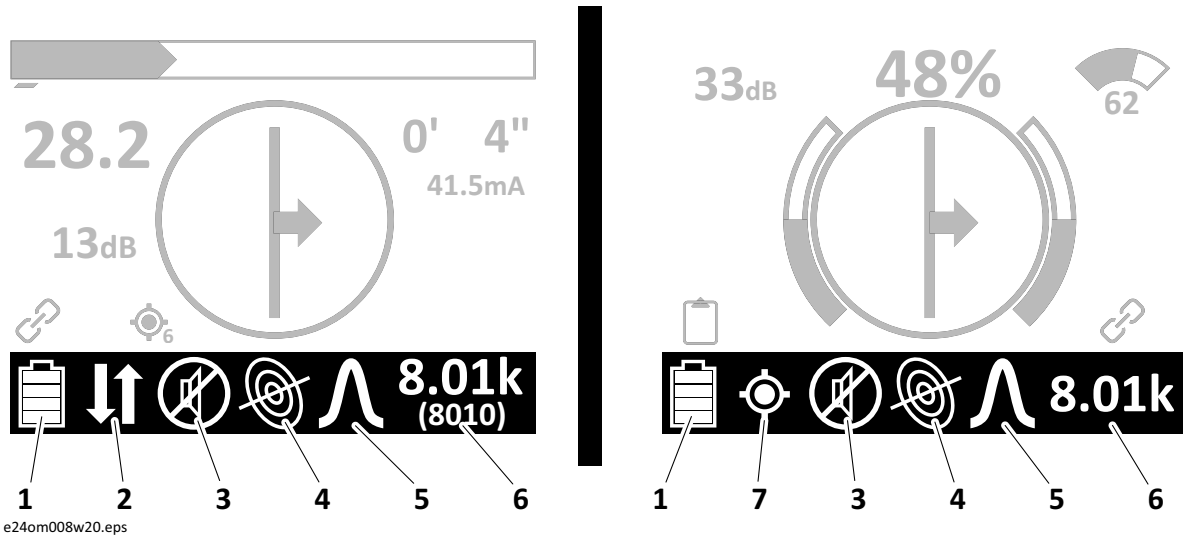

Item	Description	IMPORTANT
5. Direction arrow	Arrow indicates direction to utility.	<p>Length of arrow changes based on distance to utility.</p> <p>Arrow changes to center diamond when receiver is positioned directly above utility.</p>
6. Depth	Displays estimated depth of utility.	<p>When not shown, user can force depth to display.</p> <p>See "Mode/Depth key" on page 18.</p>
7. Current meter	Displays estimated current transmitted to utility.	
8. Range estimator	Displays estimated remaining locate range.	
9. Communication indicator	<p> Lights when no communication is received from transmitter.</p> <p> Lights when frequency is not available from transmitter.</p> <p> Lights when receiver is linked to transmitter.</p>	<p>See "Link Receiver to Transmitter" on page 31.</p>
10. Logging indicator	<p> Lights when logging is active.</p> <p> Lights when data point is successfully sent.</p> <p> Lights when data point failed to send.</p> <p> Lights when log is full.</p> <p> Lights when log is almost full.</p>	<p>See "Locate Using GPS" on page 43.</p>
11. GPS status indicator	<p> Flashes when receiver is searching for GPS signal.</p> <p> Lights when GPS signal is found.</p>	<p>See "Locate Using GPS" on page 43.</p>

Status Bar













IMPORTANT: UtiliGuard Classic shown on the right and UtiliGuard 2 and UtiliGuard 2 Advanced shown on the left. User interface can be changed in options menu.









- 1. Battery level indicator
 - 2. Direction enable indicator*
 - 3. Volume indicator
 - 4. Mode indicator
 - 5. Antenna configuration indicator
 - 6. Frequency
 - 7. GPS status indicator**
- *UtiliGuard 2 Classic only
 **UtiliGuard 2 Advanced only

Item	Description	IMPORTANT
1. Battery level indicator	 Indicates battery level.	
2. Direction enable indicator	 Lights when direction enable output is detected from transmitter.	See "Direction Enable" on page 39.
3. Volume indicator	 Indicates volume level.	

Receiver

Item	Description	IMPORTANT
<p>4. Mode indicator</p>	<p> Lights when line mode is selected.</p> <p> Lights when auto-gain mode is selected.</p> <p> Lights when beacon mode is selected.</p> <p> Lights when power mode is selected.</p> <p> Lights when radio mode is selected.</p>	<p>See "Select Mode" on page 36.</p>
<p>5. Antenna configuration indicator</p>	<p> Lights when single peak antenna is selected.</p> <p> Lights when null antenna is selected.</p> <p> Lights when twin peak antenna is selected.</p> <p> Lights when total field antenna is selected.</p>	<p>See "Antenna configuration/Menu key" on page 18.</p>
<p>6. Frequency</p>	<p>Displays frequency.</p>	
<p>7. GPS status indicator</p>	<p> Flashes when receiver is searching for GPS signal.</p> <p> Lights when GPS signal is found.</p>	<p>See "Locate Using GPS" on page 43.</p>

Menu

Item	Description	IMPORTANT
Configuration menu	 To configure receiver, select.	Frequency, mode, and antenna configuration can be adjusted in this screen. See "Prepare Equipment" on page 31.
Settings menu	 To customize settings, select.	Language, units of measurement, backlight, shutdown timer, and communications preference can be adjusted in this screen.
Options menu	 To select options, select.	Audio, gain, depth, control, and user interface options can be adjusted in this screen.
System information	 To view system information, select.	Displays receiver model configuration, model number, serial number, software version, hour count, configuration date, and calibration date.
Ambient Interference Measurement (AIM)*	 To measure and display interference, select.	See "Measure Ambient Interference" on page 37.
Transmitter information*	 To display transmitter information, select.	Transmitter must be linked to receiver. See "Link Receiver to Transmitter" on page 31.
Utility type**	 To select type of utility, select.	
Metrics**	 To display receiver metrics, select.	

* UtiliGuard 2 Advanced only.

** UtiliGuard 2 and UtiliGuard 2 Advanced only.





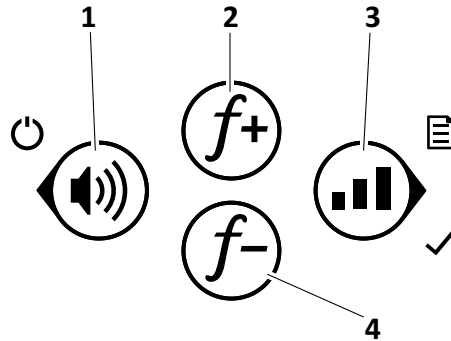

Transmitter

Keypad



e24om003w20.eps

IMPORTANT: Keypad buttons perform several functions, depending on operating mode.

Item	Description	IMPORTANT
1. Power/Volume key	 To adjust volume, press.  To turn on or off, press and hold.	When using menu, press to return to previous screen.
2. Frequency up key	 To move up through frequencies, press.	When using menu, press to move up through menu options.
3. Power output level/Menu key	 To change power output, press.  To access menu, press and hold.	When using menu, press to move to next screen/select.
4. Frequency down key	 To move down through frequencies, press.	When using menu, press to move down through menu options.

Display

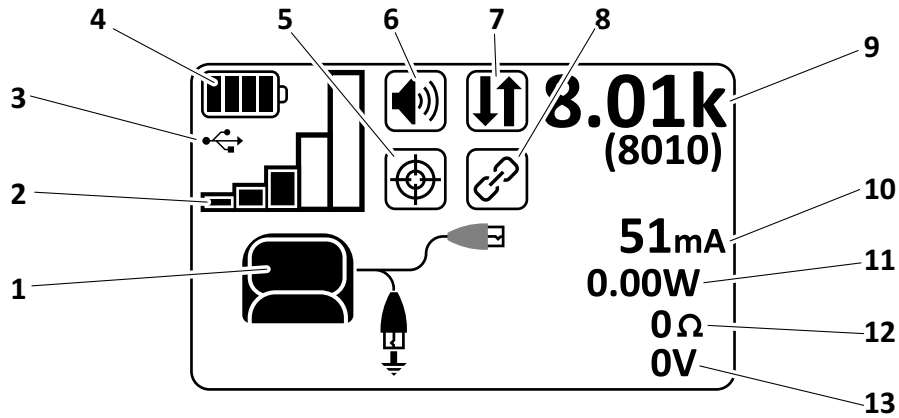





e24om004w20.eps









IMPORTANT: Transmitter displays status of selected options as well as active frequency and meter reading.

- | | |
|----------------------------------|-----------------------------|
| 1. Accessory indicator | 8. Communication indicator* |
| 2. Power output level indicator | 9. Frequency |
| 3. USB indicator | 10. Current meter |
| 4. Battery indicator | 11. Watt meter |
| 5. Power output status indicator | 12. Line impedance |
| 6. Volume indicator | 13. Volt meter |
| 7. Power output indicator | |





*UtiliGuard 2 Advanced only

Item	Description	IMPORTANT
1. Accessory indicator	 Indicates direct connect leads are connected.	See "Set Up Transmitter" on page 31.
	 Indicates induction clamp is connected.	
	 Indicates induction is active.	
2. Power output level indicator	 Displays power output level.	
3. USB indicator	 Lights when USB is connected.	

Transmitter

Item	Description	IMPORTANT
4. Battery indicator	 Indicates battery level.	
5. Power output status indicator	 Lights when power output has reached regulation.  Lights when power output has been interrupted.	Animated symbol indicates power output is still regulating.
6. Volume indicator	 Indicates volume level.	
7. Power output indicator	 Lights when direction enable is selected.  Lights when dual output is selected.  Lights when high power output is selected.	See "Select Power Output" on page 35.
8. Communication indicator	 Lights when transmitter is linked to receiver.	Flashes when establishing communication. See "Link Receiver to Transmitter" on page 31.
9. Frequency	Displays frequency.	See "Enable Frequency" on page 37.
10. Current meter	Displays current transmitted to utility.	
11. Watt meter	Displays power transmitted to utility.	
12. Line impedance	Displays line impedance.	
13. Volt meter	Displays voltage transmitted to utility.	

Menu

Item	Description	IMPORTANT
Frequency	 To enable frequency, press.	See "Enable Frequency" on page 37.
Settings menu	 To customize settings, press.	Backlight, meter options, communication preference and power output can be adjusted in this screen. See "Select Power Output" on page 35.
Options menu	 To select options, press.	Language, shutdown timer, and fault mode can be adjusted in this screen. Equipment can be restored to factory settings in this screen.
System information	 To view system information, press.	Displays transmitter model configuration, model number, serial number, software version, hour count, manufacturing date, and power source information.

Locate

Chapter Contents

	For additional precautions, see "Safety" chapter.
---	---

IMPORTANT: For locate information using accessories, see page 45.
--

- Prepare Operator 30**
- Prepare Equipment 31**
 - Link Receiver to Transmitter 31
 - Set Up Transmitter 31
 - Select Mode 36
 - Select Antenna Configuration 36
 - Measure Ambient Interference 37
 - Enable Frequency 37
 - Adjust Receiver Gain 37
- Locate Active Signal 38**
 - Direction Enable 39
 - Offset Depth 40
- Locate Passive Signal 41**
 - Peak Signal Method 42
 - Null Point Method 43
- Locate Beacon Signal 42**
- Locate Using GPS 43**
- Troubleshooting 44**

Prepare Operator

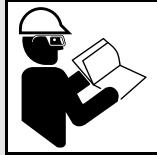

⚠ WARNING

Jobsite hazards. Exposure can cause death or serious injury. Use correct equipment and work methods. Use and maintain appropriate safety equipment.

To help avoid injury:

- Wear personal protective equipment including safety eye wear.
- Remove jewelry.
- Wear close-fitting, high visibility clothing.
- Have other personal protective equipment, such as insulated boots and gloves, breathing protection, and face shield, etc. available for use depending on jobsite hazards or requirements.

Follow these guidelines before operating any jobsite equipment:

- Complete proper training and read operator's manual before using equipment.
- Plan for emergency services. Have the telephone numbers for local emergency and medical facilities on hand. Check that you will have access to a telephone.
- Review jobsite hazards, safety and emergency procedures, and individual responsibilities with all personnel before work begins. Safety videos are available from your Ditch Witch® dealer or at www.ditchwitch.com/safe. Safety Data Sheets (SDS) are available at www.ditchwitch.com/support.
- Use equipment carefully. Stop operation and investigate anything that does not look or feel right.

Any time jobsite is classified as electric and excavation is occurring, operator must wear boots and gloves meeting the following standards:

- Boots must have high tops and meet the electric hazard protection requirements of ASTM F2413 or ASTM F1117 when tested at 18,000 volts. Tuck legs of pants completely inside boots.
- Gloves must have 17,000 AC maximum use voltage, according to ASTM specification D120.
- If working around higher voltage, use gloves and boots with appropriately higher ratings.

Prepare Equipment

This equipment allows configuration of frequencies, modes, and antenna functions based on jobsite and preference. Configurations can be saved, locked, and unlocked using configuration software.

Link Receiver to Transmitter

IMPORTANT:



- This feature is only available when using both UtiliGuard 2 Advanced receiver and transmitter.
- Once linked, devices will automatically connect when turned on.

UtiliGuard 2 Advanced receivers and transmitters can be connected through a wireless connection. Once linked, the operator can change transmitter settings with the receiver.

1. Turn both receiver and transmitter on and ensure they are not already linked.
2. Use settings menu to change communication preference. Follow on-screen prompts. Communication indicator will light when link is complete.

Set Up Transmitter

Set up transmitter for locating using transmitter accessory or broadcast induction method.

Set-up Method	Description	IMPORTANT
 Direct connect	Requires a direct electrical connection to target utility	When possible, use direct connect method. See "Direct Connect Method" on page 32.
 Clamp induction	Requires placing optional induction clamp around target utility	See "Induction Clamp Method" on page 34.
 Broadcast induction	Induces current into utilities near the transmitter	See "Broadcast Induction Method" on page 35.

Direct Connect Method



⚠ WARNING Jobsite hazards. Exposure can cause death or serious injury. Use correct equipment and work methods. Use and maintain appropriate safety equipment.

To help avoid injury:

- Contact qualified utility personnel and follow all standards and requirements for disconnecting and grounding cables.
- When using direct connect accessory, only connect to sheath of cable.
- Transmitter is automatically disabled if connected to live utility. Turn transmitter off and disconnect from utility to reset.
- Ensure transmitter is off when connecting or moving ground stake.
- Contact qualified utility personnel and follow all standards and requirements for disconnecting and grounding cables.

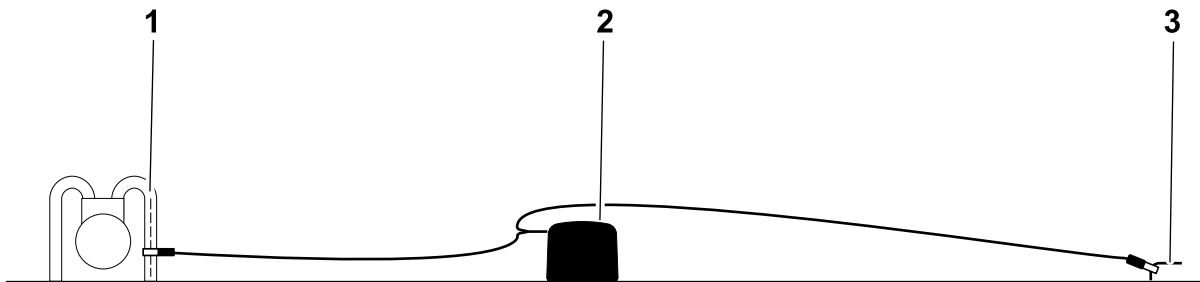

e18om028h.eps

1. Ensure transmitter (2) is off.
2. Push ground stake (3) into ground.

IMPORTANT: For more favorable grounding conditions in dry soil, apply water to ground around stake.

3. Connect cable to transmitter. See "Accessory Ports" on page 4.
4. Connect black lead to ground stake.
5. Connect red lead to utility (1).

IMPORTANT: If using dual location, connect white lead to additional utility.

6. Turn transmitter on.
7. Select power output level.

Live Power Adapter



⚠ WARNING Jobsite hazards. Exposure can cause death or serious injury. Use correct equipment and work methods. Use and maintain appropriate safety equipment.

To help avoid injury:

- Only use this mode if properly qualified to work on live power conductors.
- Do not connect to utility over 480V.
- Connect to transmitter before connecting to utility. Connect only one clamp at a time.
- When finished, disconnect from utility, then ground stake, then transmitter.
- When using live power adapter, frequency must be greater than 8kHz. Use 29kHz if possible.

IMPORTANT: When using live power adapter, frequency must be greater than 8kHz. Use 29kHz if possible.

Use live power adapter with direct connect method to protect transmitter from damage due to connection to live electrical power.

1. Ensure transmitter (3) is off.
2. Push ground stake (4) into ground.

IMPORTANT: For more favorable grounding conditions in dry soil, apply water to ground around stake.

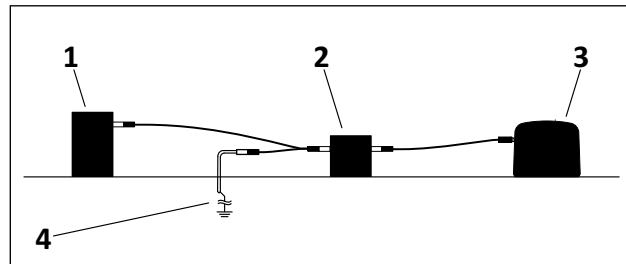

e24om009w20.eps

3. Connect live power adapter (2) to transmitter.
4. Connect black lead to ground stake.
5. Connect red lead to live power conductor (1).
6. Turn transmitter on.
7. Select power output level.

Induction Clamp Method



⚠ WARNING Jobsite hazards. Exposure can cause death or serious injury. Use correct equipment and work methods. Use and maintain appropriate safety equipment.

To help avoid injury:

- Contact qualified utility personnel and follow all standards and requirements for disconnecting and grounding cables.
- Ensure transmitter output is off before opening clamp.

IMPORTANT: Use broadband clamp for a wider range at lower frequencies. Use standard clamp at 8kHz and above.

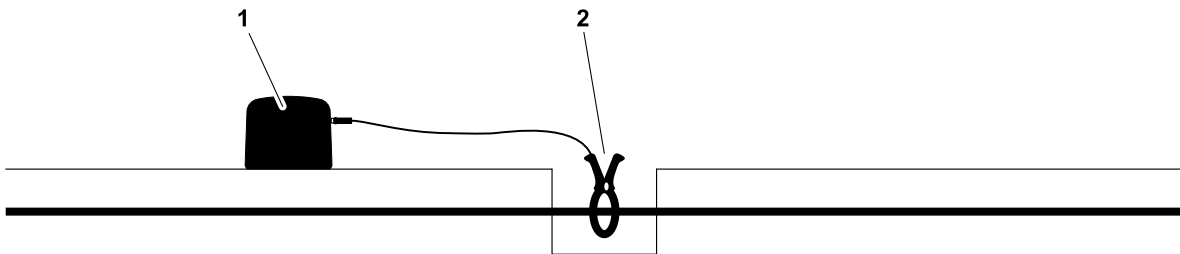

e240m025w20.eps

1. Ensure transmitter (1) is off.
2. Connect induction clamp to transmitter. See "Accessory Ports" on page 4.
3. Place clamp around cable (2). Ensure clamp is completely closed.
4. Turn transmitter on.
5. Select power output level.

Broadcast Induction Method

IMPORTANT: Ensure transmitter is away from large metal objects.

1. Remove cable, ground stake, clamp and any other metal objects from transmitter.
2. Position transmitter parallel to and directly above suspected utility as shown.
3. Turn transmitter on.
4. Select power output level.

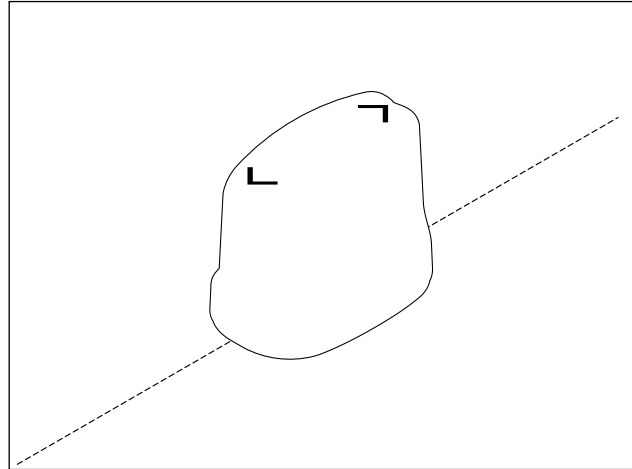



e18om025h.eps

Select Power Output

IMPORTANT:

- High power output is only available when using UtiliGuard 2 T12 and UtiliGuard 2 T12 Advanced transmitters.
- When using high power output, install a Lithium ion battery pack.

Select power output and adjust as needed while locating.



Power Output	Description	IMPORTANT
 Direction enable	Allows operator to determine direction of current in utility	See "Direction Enable" on page 39.
 Dual output	Used to locate two utilities.	Only one output provides signal at a time.
 High power output	Used to transmit 12W to utility	Can only be used at frequencies under 9kHz.

Select Mode

UtiliGuard 2 receivers detect active and passive signals. Select mode based on jobsite and preference.



Active Signal

This mode is used to locate signals from a transmitter or beacon.





Method	Description	IMPORTANT
 Line mode  Autogain mode	Used to detect current placed on a line or cable by a transmitter	Gain is automatically adjusted in auto-gain mode.
 Beacon mode	Used to detect signal transmitted from a beacon inside pipe or conduit	

Passive Signal

This mode is used to locate signals that already exist in a utility.

Method	Description	IMPORTANT
 Power mode	Used to locate utilities without using transmitter	Current must be flowing through utility.
 Radio mode	Used to locate utilities that pick up and radiate very low frequency (VLF) radio waves	

Select Antenna Configuration

Method	Description	IMPORTANT
 Single peak	Uses one horizontal antenna to detect signal	Select for wider range but less precise locating.
 Twin peak	Uses two horizontal antennas to detect signal	Select for narrower range but more precise locating.
 Null	Uses a vertical antenna to detect signal with a search width narrower than single peak configuration	Select for sharp response in non-congested areas.
 Total field	Uses a combined signal measured in all three axes to locate signal	Select when scanning to eliminate ghost signals in non-congested areas.

Measure Ambient Interference

IMPORTANT:

- This feature is only available when using UtiliGuard 2 Advanced receiver.
- When a frequency is highlighted, realtime interference is displayed.

Ambient Interference Measurement (AIM) measures interference on the jobsite. For best active signal locating, select a frequency with the lowest interference. For best passive signal locating, select a frequency with the highest interference.

1. Ensure transmitter output is off.
2. Position transmitter parallel to and directly above utility.
3. Use receiver to select AIM. Receiver will scan utility for interference (2) on up to eight enabled frequencies and indicate best frequencies based on current mode (1).
4. If needed, scroll up or down to scan additional frequencies.
5. Select desired frequency and return to locating display screen.

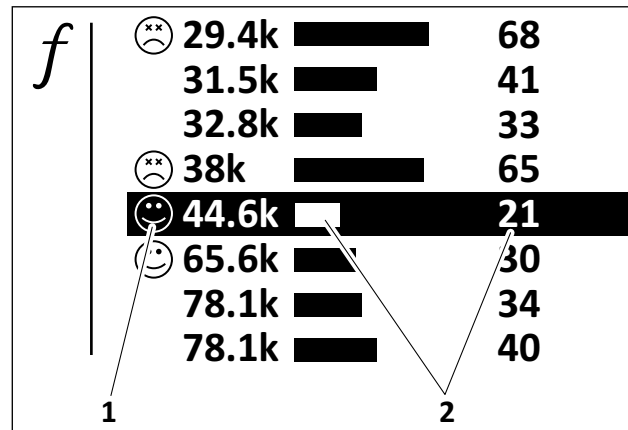

e24om026w20.eps

Enable Frequency

IMPORTANT:

- 12W power level can only be used in direct connect mode with frequencies below 9kHz.
- F1/F2 is a dual output of 8k and 29k and can only be used in low power output.
- Lower frequencies travel farther than higher ones, but higher frequencies couple onto utilities more easily.

Select frequencies based on jobsite, configuration, and power output levels. If needed, additional frequencies can be configured and added using configuration software.

On receiver, mode icons indicate mode(s) available for each frequency. On transmitter, set-up method icons indicate which set-up method is available for each frequency.

Adjust Receiver Gain

This system gives the operator the ability to adjust receiver gain. Increasing gain increases sensitivity to signal, allowing location from farther away from signal source. Decreasing gain decreases sensitivity to signal but allows for a more stable signal.

Locate Active Signal

1. Facing away from transmitter, walk in an arc approximately 25' (A, 7.5m) around transmitter, as shown.
2. Rotate receiver and observe screen:
 - 2.1 Target utility is located where signal response (1) is strongest.
 - 2.2 Adjust gain (6) as needed to maintain signal strength.

IMPORTANT: If signal strength is flashing, reduce gain.

- 2.3 Center line of compass (2) displays orientation of utility. Arrow indicates direction to utility.
3. Move in the direction of utility. When arrows form a diamond (3), utility is located.
4. Autodepth reading (4) will appear when utility is correctly located. If depth reading does not appear, force depth reading.
5. Use current measurement (5) to identify utility.
6. Continue to locate utility and observe depth estimates every few paces.
7. Once complete, retrace steps and locate utility again, marking with appropriate flags or paint.

IMPORTANT: Follow local regulations for marking utilities.

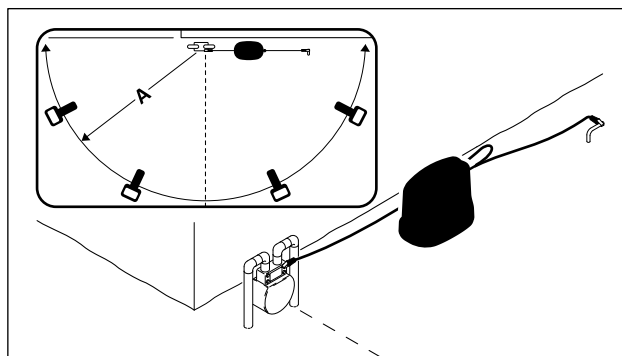

e24om009h19.eps

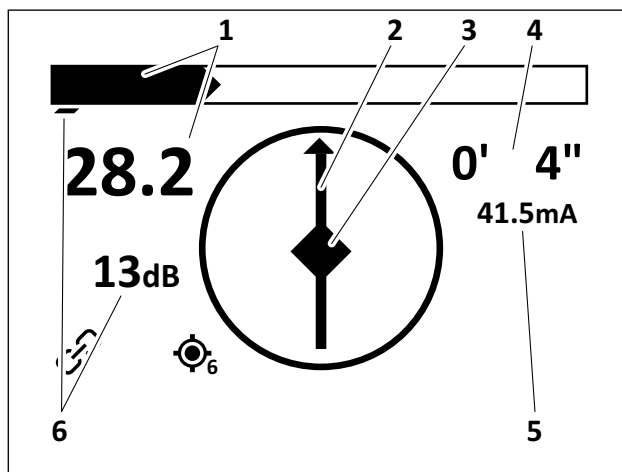

e24om011w20.eps

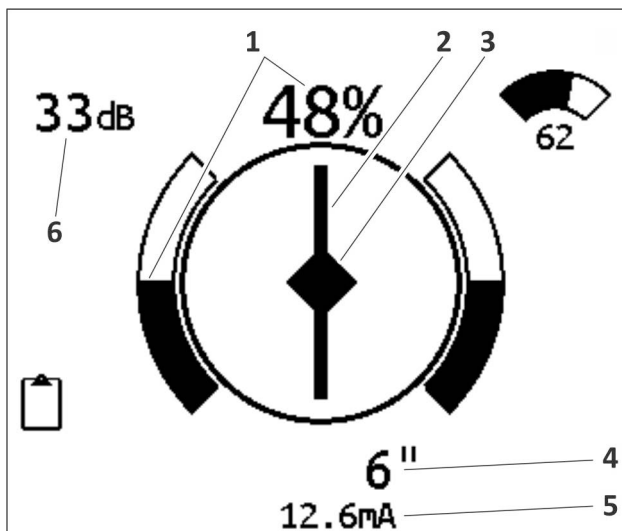

e24om003h19.png

Direction Enable

IMPORTANT:

- Must be in low power output, line mode and at a frequency below 10kHz to use direction enable.
- Power output is reduced when direction enable is in use.

Direction enable allows the operator to set a reference for current flow on a target utility. It is useful for maintaining utility identity on jobsites where multiple utilities are present.

1. On transmitter, select direction enable. See "Select Power Output" on page 35. Direction enable indicator will light.
2. Use receiver to home direction.
3. Facing away from transmitter, stand approximately 10' (3m) away and position receiver so that compass is parallel to the target utility.
4. Home direction. Arrow (shown) will appear on compass.
5. Continue locating.

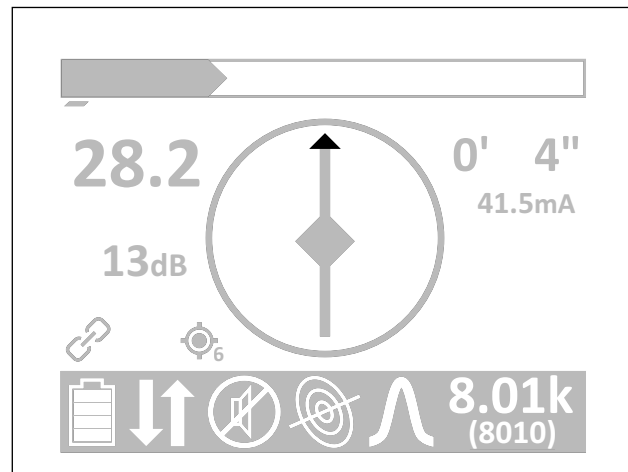

e24om014w20.eps

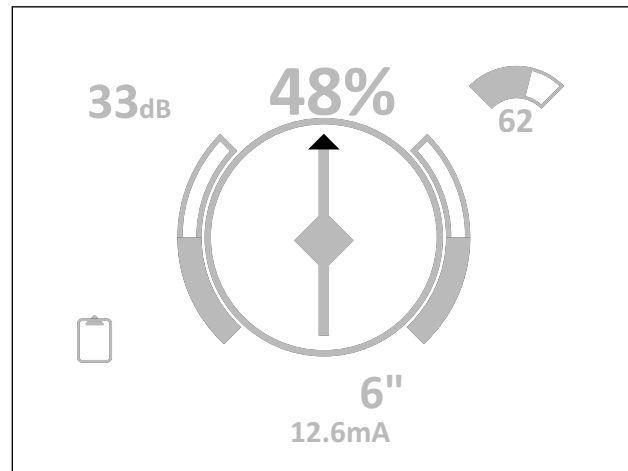

e24om015w20.eps

Offset Depth

IMPORTANT: Offset depth is only available when using UtiliGuard 2 Advanced receiver.

Offset depth uses available data to estimate horizontal distance (X) and depth (D). It is useful for locating a target utility that cannot be accessed from directly above due to obstruction.

1. Use receiver to enable offset depth.
2. Position receiver parallel to utility.
3. Tilt receiver until center diamond appears.

IMPORTANT: Receiver must be tilted between 22.5° and 60° (T) to display offset depth.

4. Read estimated distance (shown).

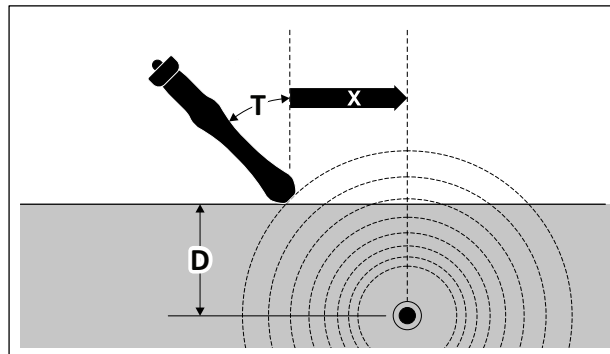

e180m027h.eps

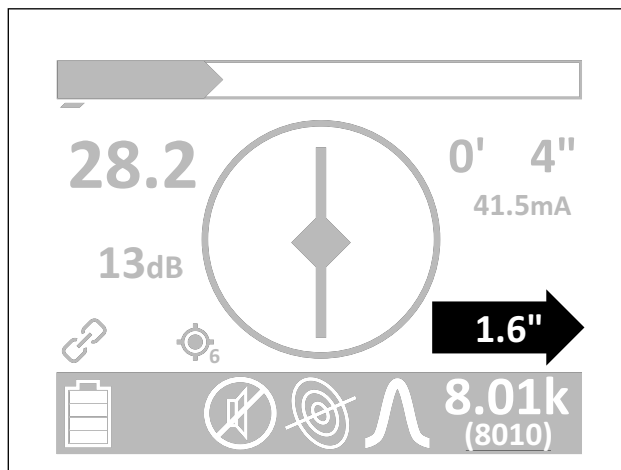

e240m012w20.eps

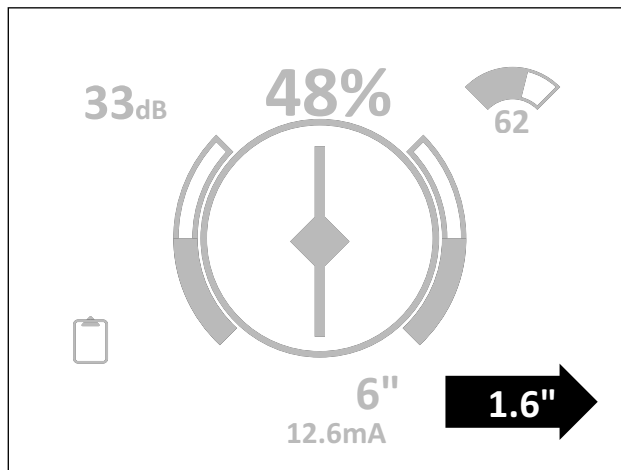

e240m013w20.eps

Locate Passive Signal

IMPORTANT: Utilities are difficult to detect with no current flowing through them. If possible, use active signal modes.

1. Survey the site for signs of buried utilities such as:
 - recent trenching
 - buried cable markers
 - overhead utilities that run down pole and underground
 - gas meters
 - valve sites
 - drains or manhole covers
2. Sweep the site by walking a grid pattern while holding receiver close to the ground as shown.
3. Focus the signal by moving the receiver over detected signal to find best signal response.
4. Trace the utility by walking along suspected path while moving the receiver from side to side across the area, keeping receiver handle parallel to suspected utility path.

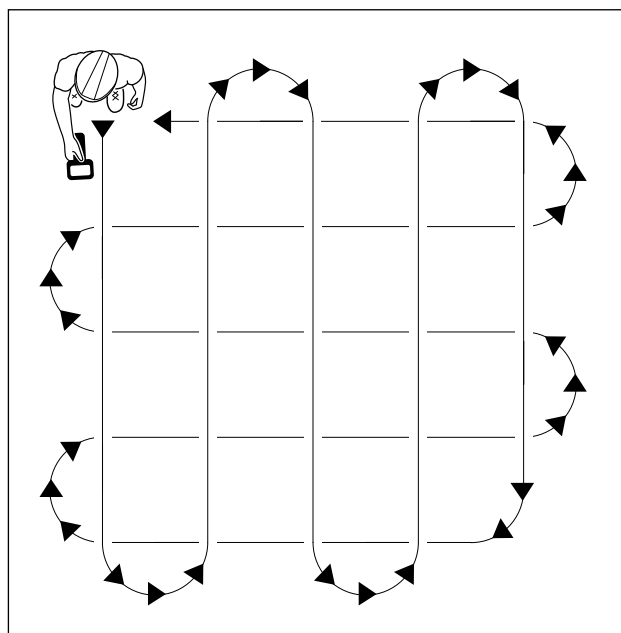

ss1076a-d.eps

Locate Beacon Signal

IMPORTANT:

- Interference will distort signal. See “Interference” on page 7.
- Total field antenna configuration must be used when locating beacon signal. See “Select Antenna Configuration” on page 36.

1. Turn receiver on to ensure beacon is working properly.
2. Attach beacon to plumber's snake or flex rod.
3. Set mode to beacon mode. See “Select Mode” on page 36.
4. Place beacon in pipe and move down pipe.
5. Locate beacon using peak signal or null point method.

Peak Signal Method

1. Select total field antenna configuration. See “Select Antenna Configuration” on page 36.
2. Identify location with the strongest signal response.
3. Follow rotation arrows (1) to rotate receiver handle as shown so that it is perpendicular to beacon.
4. Use direction arrow to center receiver over beacon.
5. Move forward and back as shown to locate strongest signal response. Autodepth reading will appear when beacon is correctly located. If depth reading does not display, force depth reading.

IMPORTANT: Estimated depth will be to center of beacon, not top of pipe.

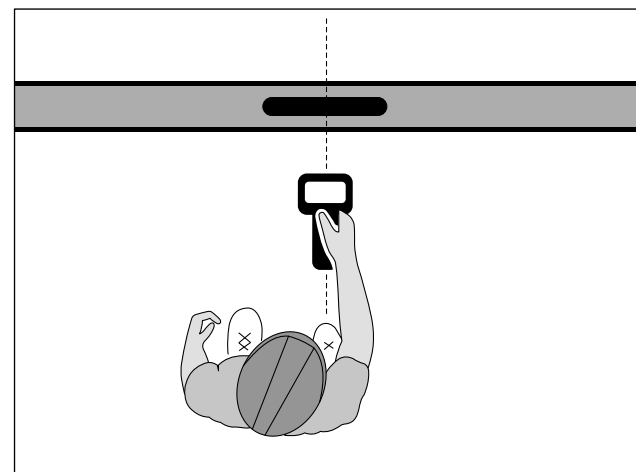
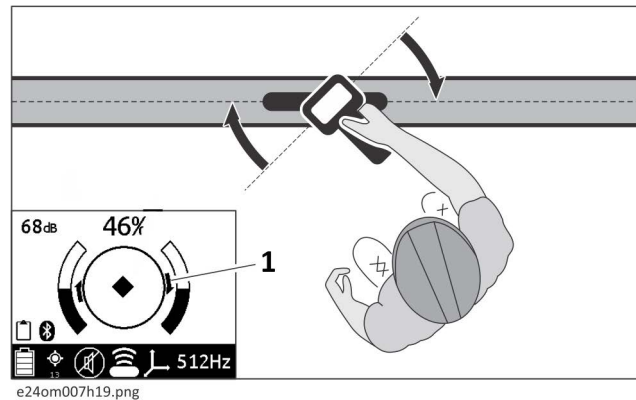

Null Point Method

IMPORTANT: Null point method is useful for locating deep beacons.

1. Circle over approximate location.
2. Follow directional arrows (2) to locate the null point (1).
3. Beacon is correctly located at peak signal between null points.

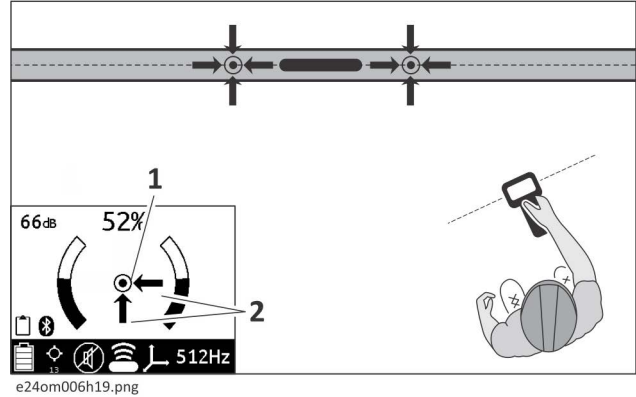

Locate Using GPS

IMPORTANT: This equipment can be used with an external GPS device. To pair receiver to GPS device, see GPS manual instructions.

UtiliGuard 2 and UtiliGuard 2 Advanced receivers are equipped with internal GPS to log location data. To log data points, use MyUtiliGuard® app. When in logging mode, data point will automatically be logged when forced depth is taken.

Troubleshooting

IMPORTANT: If utility depth and location are critical, confirm by careful hand digging or soft excavation.

Distortions in the electromagnetic field around a utility can affect location accuracy. Tees, bends, parallel utilities, crossing utilities, and large metallic objects can distort signals.

Shadows, also called blind spots, often happen when a metallic object partially obstructs the signal, or a signal from a parallel utility interferes with target utility signal.

Situation	Suggested Resolution
Signal is lost	Walk in a circle to detect a tee or bend in the utility.
Signal varies from low to high and is unstable	Mark as a hand-dig area.
Center diamond and twin signal do not agree	Use twin signal.
Receiving interference near a power line	Sweep the area in power mode. If receiver gives a strong signal response, a power line is interfering with transmitter signal.
Receiving secondary (ghost) signals	Identify beacon location at main signal. Use total field antenna configuration, if possible.
Receiver does not function properly	Adjust gain to locate the utility.
Target utility has connections to other utilities	Disconnect target utility from other utilities or use direct connect or induction clamp to focus signal on target utility.
Signal is transferring to other utilities	Lower frequency. Use direct connect or induction clamp, if possible. Move ground stake away from target utility and away from other buried utilities. Apply signal at the point where target utility is farthest from other utilities. Use depth estimate or direction enable to identify correct utility.
GPS device or receiver is not paired.	Un-pair or remove device and re-pair.
GPS pairing fails	Enter "0000" passcode to pair.

Accessories

Chapter Contents



For additional precautions, see "Safety" chapter.

IMPORTANT: This chapter contains information for operating specific accessories. For more information on standard operation, see "Controls" and "Locate" chapters.

EML Accessory 46

- Controls 46
- Locate Markers 48

Fault Finder Accessory 49

- Controls 49
- Locate Faults 50

Receiver Clamp Accessory 53

- Controls 53
- Locate Using Receiver Clamp 53

Stethoscope Accessory 54

- Controls 54
- Locate Using Stethoscope 54

EML Accessory

This accessory is used to locate electronic markers. It allows users to find any standard electronic marker used to mark specific locations for future locating.

Controls

Receiver Keypad

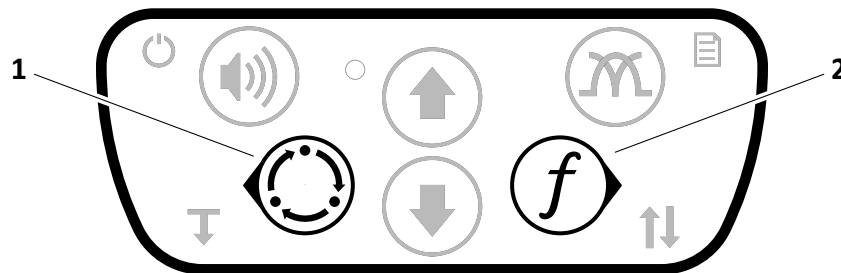







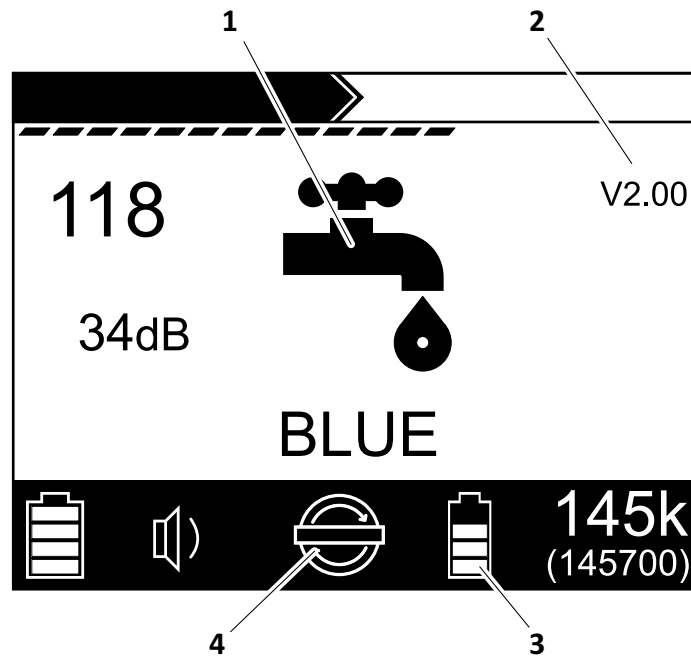



e24om024w20.eps

Item	Description	IMPORTANT
1. Select marker type	<i>f</i> To select marker type, press.	
2. Scan mode	 To select scan mode, press.	

Receiver Display



e24om016w20.eps

Item	Description	IMPORTANT
1. Marker ball indicator	 Water  Non-potable water  Waste water  Communications  Phone  Gas  Power	Blue (145k) Purple (66.3k) Green (121k) Black/Orange (77.0k) Orange (101k) Yellow (83.0k) Red (169k, non-EU only) Red/Blue (134k, EU only)
2. EML accessory software version	Displays software version.	
3. EML mode indicator	 Indicates normal mode.  Indicates scan mode.	
4. EML accessory battery level	 Indicates battery level.	

Locate Markers

Set Up

1. Place receiver wand into recess of EML accessory.
2. Insert strap (1) through buckle (2).
3. Tighten strap using buckle ratchet (3) as shown.

NOTICE: Do not over-tighten.

4. Turn receiver on.
5. Connect cable to receiver. See "Accessory Ports" on page 4. EML mode indicator will light.

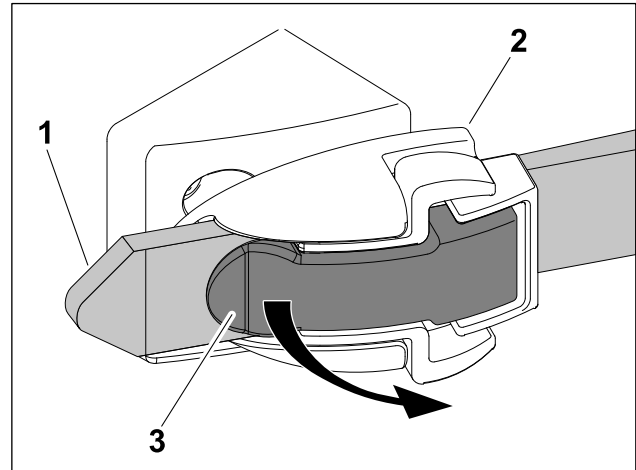

e18om073h.eps

IMPORTANT: Receiver will remain in EML mode until EML accessory is disconnected.

Locate Marker

IMPORTANT: If marker type or location is unknown, use search mode to locate all frequencies and display information for the marker with the highest signal.

1. Select marker ball type.
2. Place marker ball on ground and test operation.
3. Hold EML accessory close to the ground and move from side to side over marker ball location.
4. Move in the direction of increasing signal strength. Marker is located at strongest signal response.
5. To locate next marker, adjust gain and repeat process.

Disconnect

1. Disconnect EML cable from receiver.
2. Set EML accessory on solid surface.
3. Hold receiver (2) while pushing both levers (1) toward EML accessory.
4. When buckle clicks, continue pressing levers and twist receiver to loosen strap enough to disconnect.

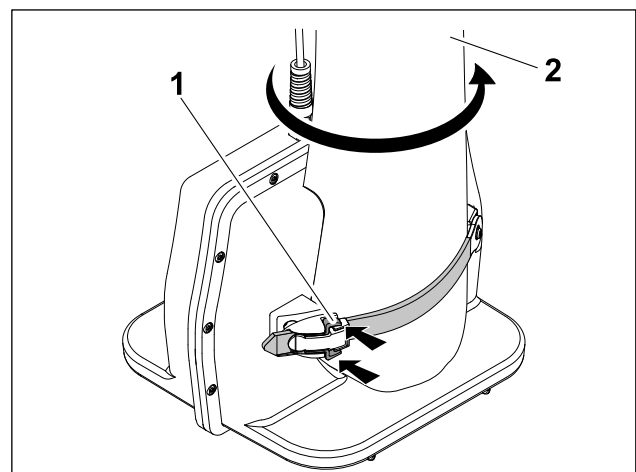

48-073h

Fault Finder Accessory

IMPORTANT: Fault mode is only available when using direct connect method.

This accessory locates earth return faults that are created when a utility directly contacts the earth. It is useful for locating faults on direct-buried power, telephone, cable, and sheathed tracer wire.

Controls

Receiver Keypad

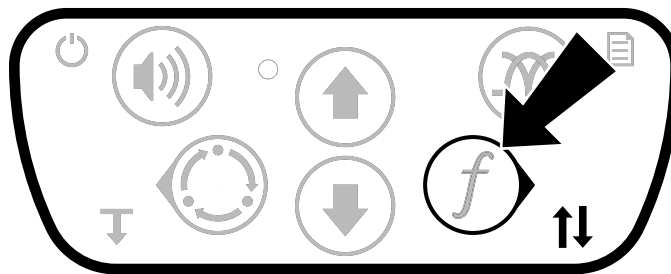



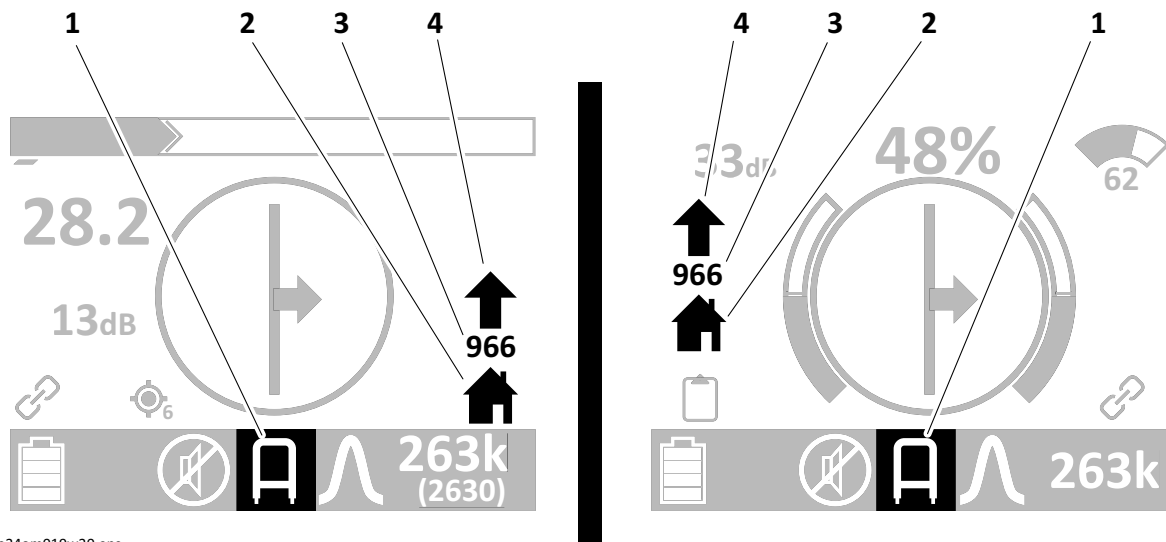

e24om020w20.eps

Item	Description	IMPORTANT
Home fault key	<i>f</i> To home fault system, press and hold.	

Receiver Display



e24om019w20.eps

Item	Description	IMPORTANT
1. Fault mode indicator	 Indicates fault mode is active.	
2. Homing indicator	 Lights when homing is required.	
3. Signal strength	Indicates signal strength	
4. Fault direction indicator	 Indicates fault is located in front of receiver.  Indicates fault is located behind receiver.	

Locate Faults

Survey the site for signs of a faulted utility:

- recently disturbed soil
- past splices
- “buried utility” notices
- utility facilities without overhead utilities
- junction boxes
- drop boxes
- light poles
- sunken ground

Set Up Transmitter

IMPORTANT: If fault is present, impedance reading will be less than 50k Ω . Impedance reading of more than 100k Ω indicates no significant fault exists on the utility.

1. De-energize and disconnect utility at both ends.

IMPORTANT: Do not use breaker.

2. Connect direct connect lead into transmitter. See "Accessory Ports" on page 4.
3. Connect black lead of transmitter to ground stake.
4. Connect red lead to one end of faulted utility.
5. Turn transmitter on and select fault mode. Fault mode indicator will light.
6. If needed, increase power level until current reading is at 5mA or transmitter is at highest power level.

Set Up Receiver and Fault Probe

IMPORTANT: Receiver can also locate utilities while in fault mode at 263kHz.

1. Turn receiver on.
2. Connect fault probe to receiver. See "Accessory Ports" on page 4. Fault mode indicator will light and homing indicator will flash.

Locate Fault

IMPORTANT: Keep fault probe and receiver oriented the same direction while fault finding.

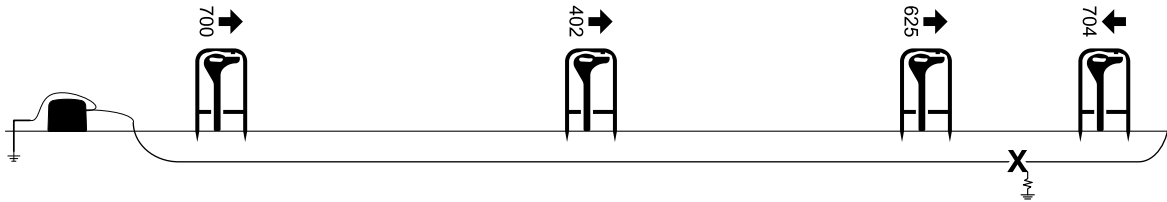

e13om062h.eps

1. Locate utility.

IMPORTANT: If location is unknown, draw straight line between two disconnected ends of isolated utility (1, 4).

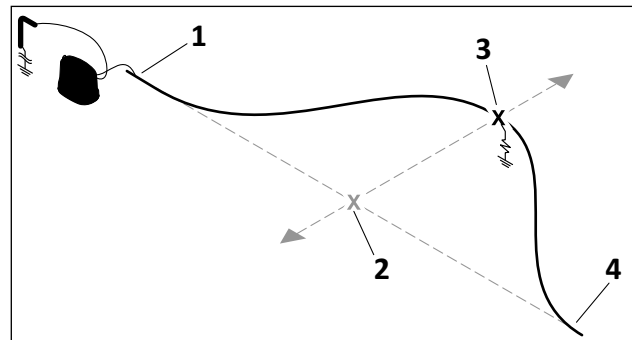

e24om022w20.eps

2. With back toward transmitter, move down faulted utility approximately 3' (1m).
3. Align fault probe parallel with utility and push into soil.
4. Once signal strength numbers appear, home fault system. Chime will sound and fault direction indicator will light.
5. Follow fault direction indicator to find fault location, repeating steps 3-5 as needed.

IMPORTANT: If location of utility is unknown, find fault on straight line (2). Rotate fault probe 90° and repeat location process to find location of fault (3).

6. After fault is fixed, repeat process to locate additional faults.

Receiver Clamp Accessory

NOTICE: When connecting to power lines, place around insulated conductors only.

IMPORTANT: This accessory can only be used in line mode or power mode. Use mode key to select.

This accessory is used to identify a target utility in a vault or utility box with multiple utilities.

Controls

Receiver Display

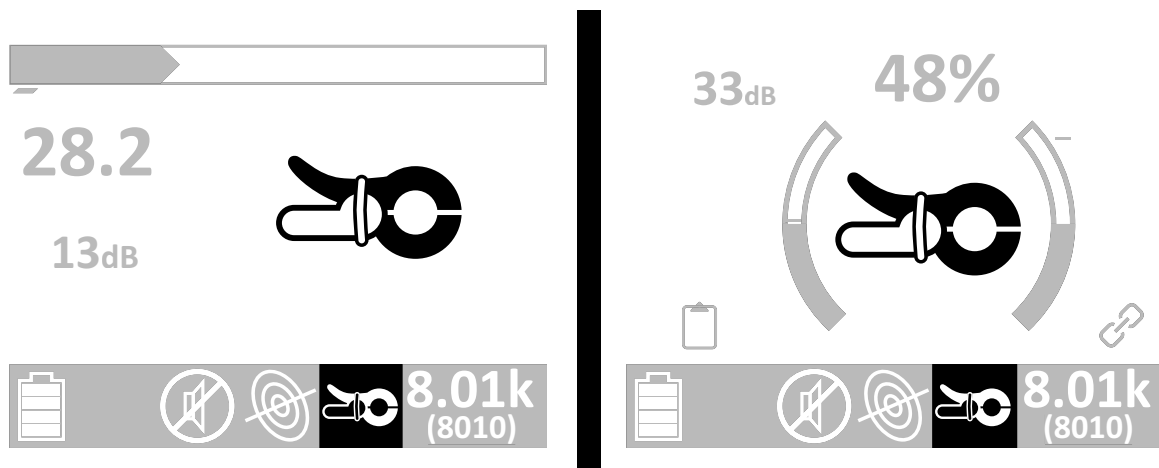

e24om017w20.eps

Item	Description	IMPORTANT
Receiver clamp mode indicator	 Lights when receiver clamp mode is active.	

Locate Using Receiver Clamp

1. Turn receiver on.
2. Connect receiver clamp cable into receiver. See “Accessory Ports” on page 4. Receiver clamp mode indicator will light.
3. Select desired frequency.
4. Place clamp around target utility.

Stethoscope Accessory

NOTICE: When connecting to power lines, place around insulated conductors only.

IMPORTANT: This accessory can only be used in line mode or power mode. Use mode key to select.

This accessory is used to identify utilities in cabinets with multiple utilities.

Controls

Receiver Display

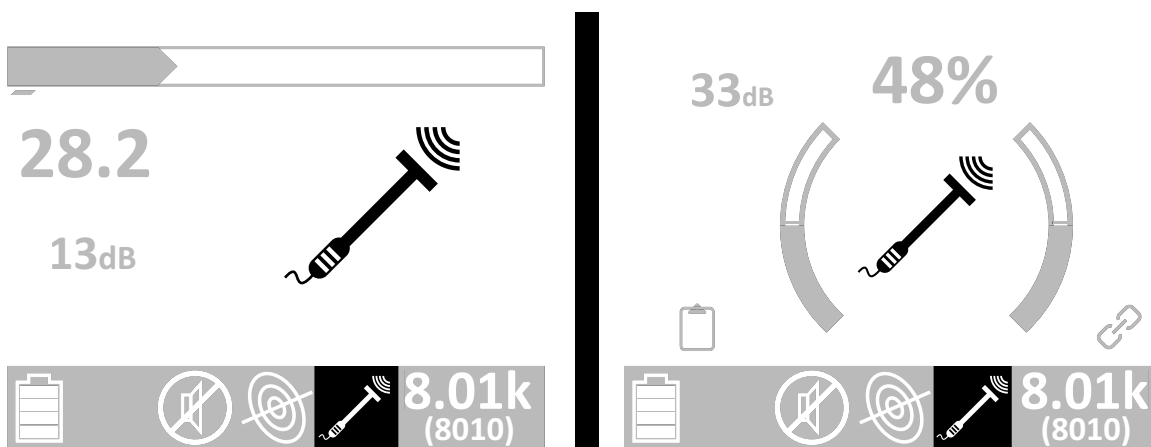

e240m018w20.eps

Item	Description	IMPORTANT
Stethoscope mode indicator	 Lights when stethoscope mode is active.	

Locate Using Stethoscope

1. Turn receiver on.
2. Connect stethoscope cable into receiver. See "Accessory Ports" on page 4. Stethoscope mode indicator will light.

3. Select desired frequency.
4. Grip stethoscope by handle and position head (2) as close to target utility (1) as possible as shown.

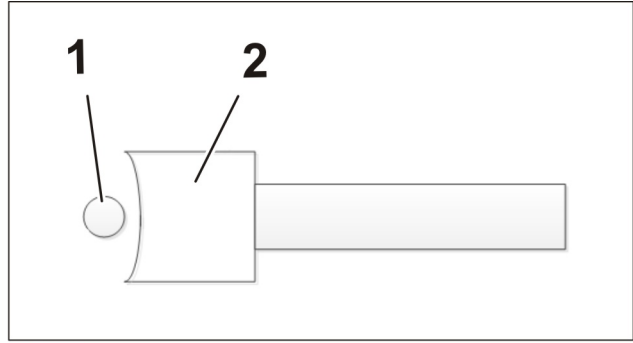

in136d.jpg

Maintenance

Chapter Contents

	For additional precautions, see "Safety" chapter.
---	---

General Care 58

Change Batteries 58

General Care

Under normal operating conditions, this equipment needs only minor maintenance. To ensure longer equipment life:

- Do not drop.
- Do not expose to high heat.
- Clean with damp cloth and mild soap.
- Do not immerse in liquid.
- Inspect housing daily for cracks or other damage. If damaged, contact your Subsite Electronics dealer for replacement.

Change Batteries

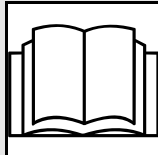
**⚠ WARNING**

Misuse of equipment can cause death or serious injury. Read and understand operator's manual and all other safety instructions before use.

**⚠ WARNING**

Corrosive fluid. Contact can cause death or serious injury. Avoid contact. Wear appropriate gloves. See Safety Data Sheet (SDS) for more information.

To help avoid injury:

- Never attempt to charge a battery that is leaking, bulging, heavily corroded, frozen, or otherwise damaged.
- Refer to Safety Data Sheet (SDS) for additional information regarding battery.

NOTICE: Do not mix new and used batteries.

Receiver

1. Remove battery cover.
2. Remove batteries.
3. Insert 2 D-cell batteries as shown.
4. Replace battery cover.

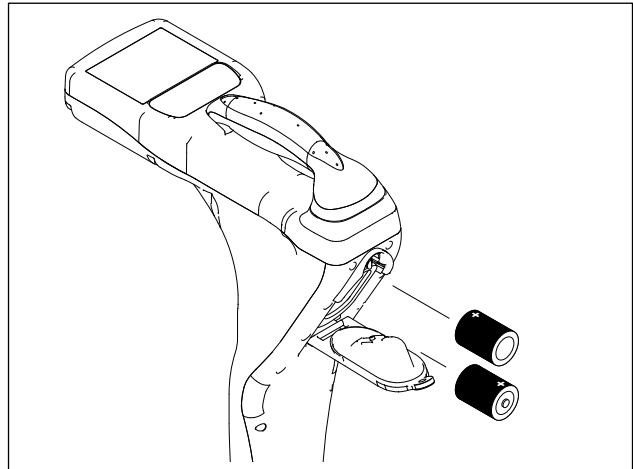

e18om003h.eps

Transmitter

1. Remove battery cover.
2. Insert 10 D-cell batteries as shown.

IMPORTANT: Lithium-ion battery pack can be used. See page 64 for more information.

3. Replace battery cover.

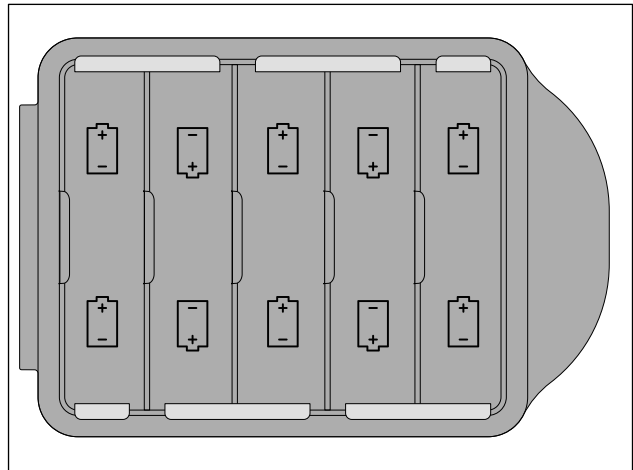

e18om008h.eps

EML Accessory

1. Remove battery cover.
2. Remove battery tray.
3. Insert batteries into tray as shown.
4. Replace battery tray.
5. Replace battery cover.

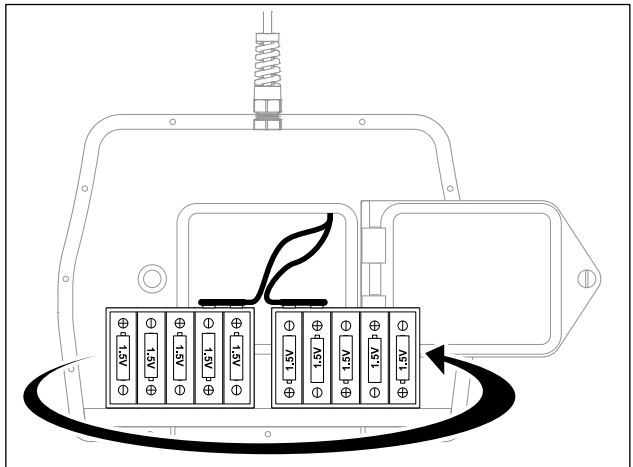

e18om069h.eps

Specifications

Chapter Contents

Receiver 62

Transmitter 64

Receiver

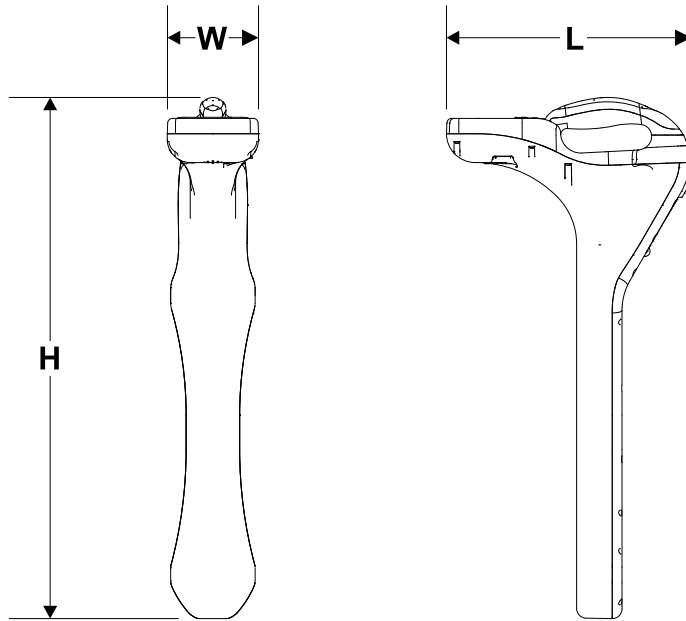

e18om001h.eps

Dimensions		US	Metric
H	Height	27.2in	69.1cm
L	Length	12.8in	32.5cm
W	Width	4.8in	12.2cm
Weight		4.8lb	2.2kg

Operation		US	Metric
-----------	--	----	--------

IP rating: IP65

Temperature

	Operating temperature	-4°F to 122°F	-20°C to 70°C
	Storage temperature	-25°F to 158°F	-32°C to 70°C

Depth

	Max autodepth	20.0ft	6.0m
	Max forced depth	40.0ft	12.0m

Max power output (only direct connect method below 9kHz)		12W	12W
--	--	-----	-----

Batteries		US	Metric
Type	D-cell alkaline		
Life*	UtiliGuard 2 Classic: approximately 30 hours continuous use/60 hours intermittent use		
	UtiliGuard 2: approximately 20 hours continuous use/50 hours intermittent use		

*If operating at 70°F (21°C).

Transmitter

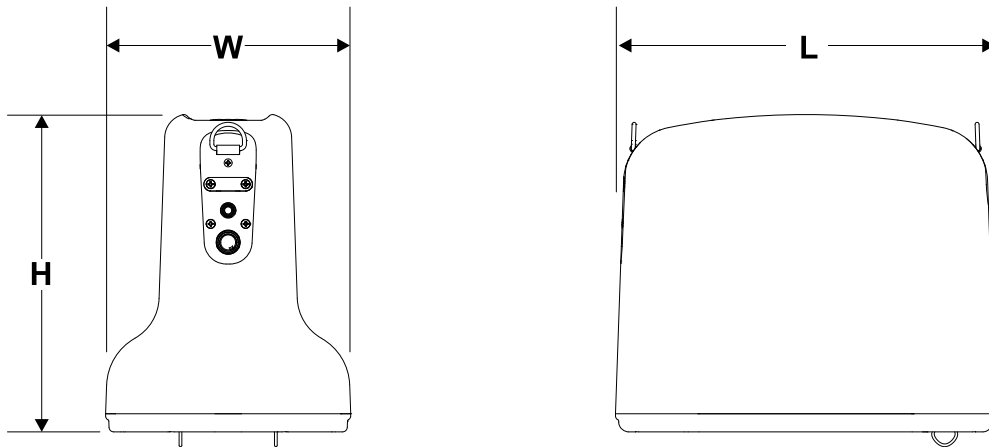

e18om002h.eps

Dimensions		US	Metric
H	Height	10.0in	25.4cm
L	Length	12in	30.5cm
W	Width	7.8in	19.1cm
Weight		7.8lb	3.5kg

Operation		US	Metric
IP rating: IP65			
Operating temperature		-4°F to 122°F	-20°C to 50°C
Max power output		12W	12W

Batteries		US	Metric
Type	D-cell alkaline or lithium ion battery pack (p/n220-2221)		
Life*	Alkaline: approximately 100 hours		
	Lithium ion: approximately 80 hours		

* When operating at power level 2.

Support

Procedure

Notify your dealer immediately of any malfunction or failure of Subsite Electronics equipment.

Always give model, serial number, and approximate date of your equipment purchase. This information should be recorded and placed on file by the owner at the time of purchase.

Return damaged parts to dealer for inspection and warranty consideration if in warranty time frame.

All repairs must be done by an authorized Subsite Electronics repair facility. Repairs done elsewhere will void warranty.

Resources

Publications

Contact your dealer for publications and videos covering safety, operation, maintenance, and repair of your equipment.

Training

For information about on-site individualized training, contact your dealer.

Warranty

Electronics Limited Warranty Policy

Subject to the limitation and exclusions herein, free replacement parts and labor will be provided when a unit fails due to a defect in material or workmanship within one (1) year of first commercial use. (See exceptions below for specific products.) Defects shall be determined through inspection by Manufacturer or authorized repair centers. An inspection must occur within thirty (30) days of the date of failure of the product or part by Manufacturer or its authorized repair facility. Manufacturer will provide the location of its inspection facilities or its nearest authorized dealer upon inquiry. Manufacturer reserves the right to supply remanufactured replacement parts under this warranty as it deems appropriate. Each warranty repair carries the remainder of the factory warranty or ninety (90) days, whichever is longer, for all repaired components and labor.

Product Warranty Exceptions:

- HDD guidance beacons, Locate Beacons and Accessories, carry a six (6) month warranty.
- HDD guidance beacons, M-Series and T-Series, carry a three (3) year 750 hour warranty.
- All Used (Cosmetic) Electronics products sold from Manufacturer carry a six (6) month warranty from date of sale to dealer

Exclusions from Product Warranty

- All defects or damages caused by misuse, abuse, improper installation, alteration, neglect, modification, lack of maintenance, or uses
- All defects or damages caused by misuse, abuse, improper installation, alteration, neglect, modification, lack of maintenance, or uses other than those for which the products were intended.
- All defects, damages, or injuries caused by improper training, operation, or servicing of products in a manner inconsistent with manufacturer's recommendations.
- All batteries, which are considered consumable and therefore not covered under this warranty.
- All damaged plastics are considered to be the result of misuse or neglect unless Manufacturer has determined otherwise.
- All repairs or attempted repairs by non-certified repair facilities or personnel will void the warranty.
- All incoming duties and freight charges.
- Manufacturer reserves the right to make changes in design and/or improvements to products from time to time, and user understands that Manufacturer shall have no obligation to upgrade any previously manufactured product to include any such changes.
- In no event shall Manufacturer or its agents, assigns, or parent company be liable for any indirect, special, incidental, or consequential damages or for any cover, loss of information, profit, revenue, or use based upon any claim by user for breach of warranty, breach of contract, negligence, strict liability or any other legal theory. In no event shall Manufacturer liability exceed the amount user has paid for the Manufacturer product.
- Manufacturer will not be responsible for loss of accessories or loss or erasure of data storage media.
- Should it be determined that applicable law prohibits enforcement of any provision of this Warranty Policy, then to the extent it is necessary to comply with the applicable law, this Warranty Policy shall be deemed amended.
- This Warranty Policy shall be the entire agreement between Manufacturer and the Purchaser. Any statements that purport to be different than or modify or expand the terms set forth in this written policy are not effective for any purpose. ANY IMPLIED WARRANTIES, INCLUDING WARRANTIES OF MERCHANTABILITY AND FITNESS FOR A PARTICULAR USE ARE EXPRESSLY DISCLAIMED. IN NO EVENT SHALL SUBSIT ELECTRONICS, THE CHARLES MACHINE WORKS, INC., OR ANY AUTHORIZED SERVICING AUTHORITY BE RESPONSIBLE FOR ANY LOSSES, INCLUDING CONSEQUENTIAL AND INCIDENTAL DAMAGES, EXCEPT AS EXPRESSLY PROVIDED HEREIN.

Service and Repair

Units repaired at Manufacturer's location or an authorized service center will carry a 90-day warranty on all replaced components/parts and labor commencing on the date of repair.

HDD guidance beacons, M-Series and T-Series repairs: If a lower assembly is replaced on any T-Series beacons, the 750-hour count will start over at zero (0) hours. The warranty years will continue from date of product registration.

M-Series beacons: M-Series beacons are not repairable. Warranty assessments can only be done at an authorized Subsite Electronics repair center. If found to be defective, Authorized Service Center may replace with new beacon.

M-Series and T-Series beacons that are past the three (3) year warranty will have a 90-day repair warranty.

Extended Warranty

Consult your local Subsite dealer for extended warranty options.

Warranty Details

For information regarding this warranty policy, contact Subsite Product Support at (800)846-2713 ext. 1; mail us at 1950 W. Fir, Perry, OK 73077; or contact your local dealer.

April 2021

